

Operating Manual Pt1000 Precision Thermometer
For exchangeable probes, with alarm

as of version V1.0

GMH 285 / GMH 285-BNC

GMH 285



GMH 285-BNC



Index

1	DESIGNATED USE	2
2	GENERAL NOTE	2
3	SAFETY REQUIREMENTS.....	3
4	DISPLAY AND CONTROL ELEMENTS.....	3
4.1	DISPLAY ELEMENTS	3
4.2	CONTROL ELEMENTS	3
4.3	CONNECTIONS	3
4.4	POP-UP CLIP	4
5	START OF OPERATION	4
6	SOME BASICS OF PT 1000 PRECISION TEMPERATURE MEASUREMENT	5
7	CONFIGURATION OF THE DEVICE	6
8	ADJUSTMENT.....	7
9	ERROR AND SYSTEM MESSAGES	7
10	ACCURACY INSPECTION: ADJUSTMENT /UPDATE SERVICE.....	7
11	DISPOSAL NOTES.....	8
12	TECHNICAL DATA.....	8

1 Designated Use

The device is measuring temperature in °C or °F.

A suitable Pt1000 temperature probe has to be connected for operation.

The safety requirements (see below) have to be observed.

The device must be used only according to its intended purpose and under suitable conditions.

Use the device carefully and according to its technical data (do not throw it, strike it, ...).

2 General Note

Read this document carefully and get used to the operation of the device before you use it. Keep this document within reach for consulting in case of doubt.

If the device is stored at temperatures above 50°C the battery has to be removed from the device.

NOTE: We recommend taking out battery if device is not used for a longer period of time.



Risk of leakage!

3 Safety Requirements

This device has been designed and tested in accordance with the safety regulations for electronic devices. However, its trouble-free operation and reliability cannot be guaranteed unless the standard safety measures and special safety advises given in this manual will be adhered to when using the device.

1. Trouble-free operation and reliability of the device can only be guaranteed if the device is not subjected to any other climatic conditions than those stated under "Specification".

If the device is transported from a cold to a warm environment condensation may cause in a failure of the function. In such a case make sure the device temperature has adjusted to the ambient temperature before trying a new start-up.

2. **WARNING:** If there is a risk whatsoever involved in running it, the device has to be switched off immediately and to be marked accordingly to avoid re-starting.



Operator safety may be a risk if:

- there is visible damage to the device
- the device is not working as specified
- the device has been stored under unsuitable conditions for a longer time.

In case of doubt, please return device to manufacturer for repair or maintenance.

3. **WARNING:** Do not use these products as safety or emergency stop devices or in any other application where failure of the product could result in personal injury or material damage.



Failure to comply with these instructions could result in death or serious injury and material damage.

4 Display and Control Elements

4.1 Display elements



main display standard	Display of the current temperature
arrow up	Display of maximum temperature
arrow down	Display of minimum temperature
HLD	Display of Hold-value
BAT	BAT-Warning: pls. change battery

4.2 Control elements

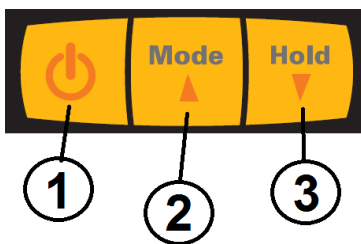

key 1: **on/off key**, press shortly: reactivate Backlight

key 2: **Mode**
 press shortly: minimum value
 press again: maximum value
 press again: return to standard display
 press for 2 sec.: reset minimum and maximum values

key 3: **Hold:**
 press shortly: The current value is 'frozen'
 (hold-function), 'HLD' is displayed

4.3 Connections

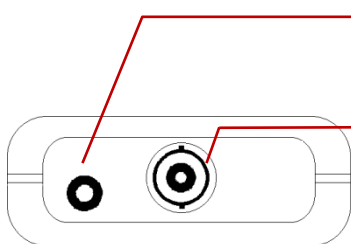

interface: connection for galv. Isolated interface adapter (accessory: GRS 3100, GRS3105 or USB3100)

BNC-socket (GMH 285-BNC)
or 3.5mm audio socket (GMH 285):
 Connection for Pt1000 temperature probe

4.4 Pop-up clip

Handling:

- Pull at label “open” in order to swing open the pop-up clip.
- Pull at label “open” again to swing open the pop-up clip further.

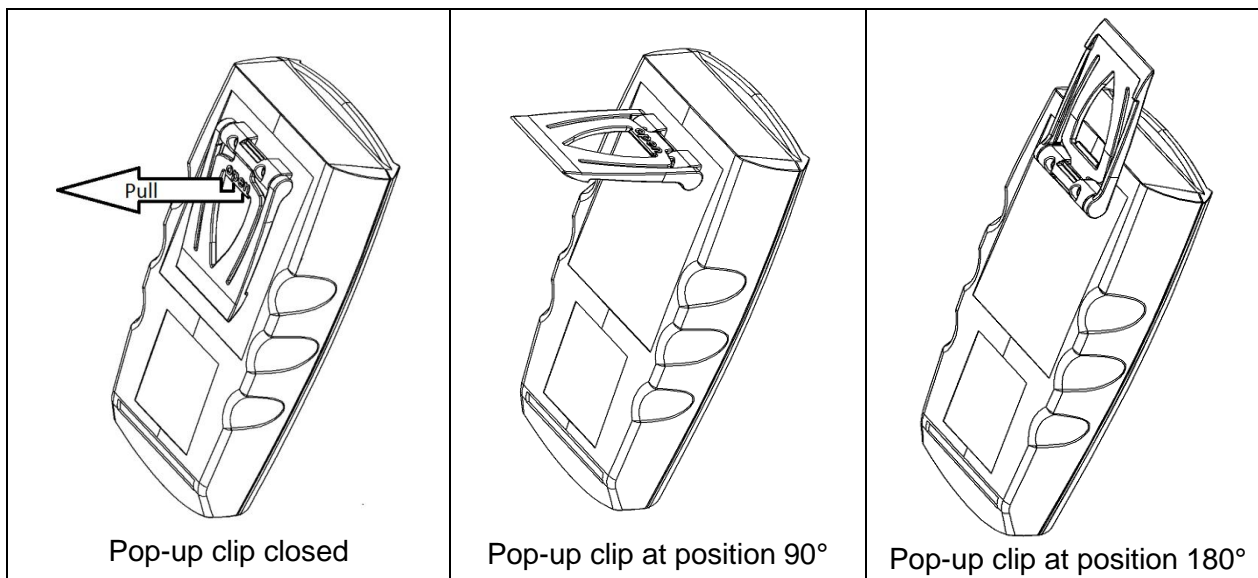

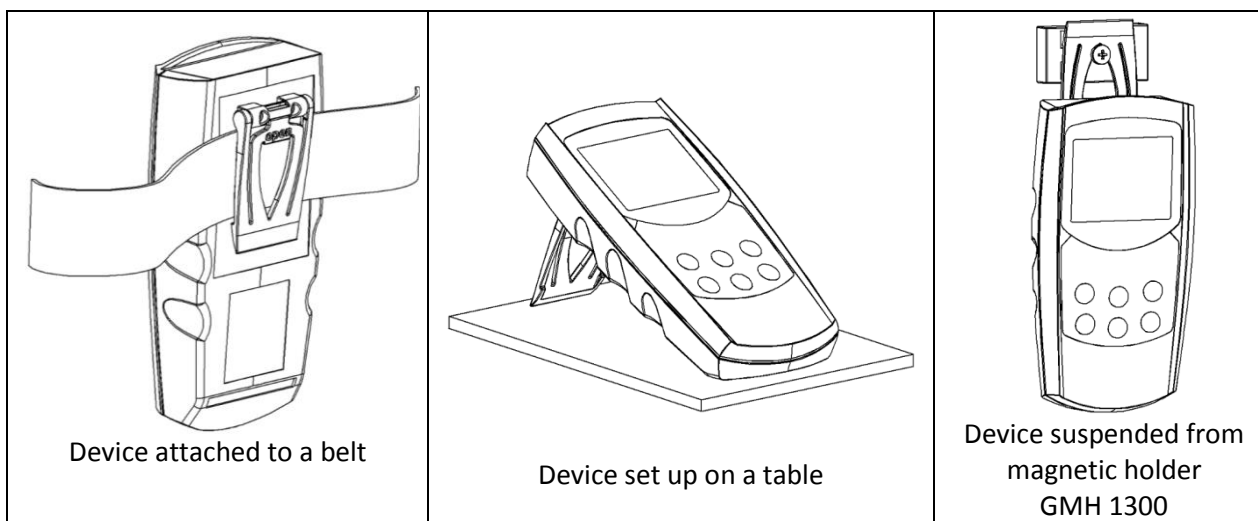

Function:

- The device with a closed pop-up clip can be plainly laid onto a table or attached to a belt, etc.
- The device with pop-up clip at position 90° can be set up on a table, etc.
- The device with pop-up clip at position 180° can be suspended from a screw or the magnetic holder GMH 1300.



5 Start of Operation

Switch the device on with the key . After segment test  the device displays some information to its configuration:

- DC OF** selected display unit (p.r.t. chapter 8)
 - OFFS** if there is a offset adjustment (p.r.t. chapter 8)
 - SCAL** if there is a slope adjustment (p.r.t. chapter 8)
 - P.off** if the automatic-off-function is activated (p.r.t chapter 6)
- The device starts measurement afterwards.

6 Some Basics Of Pt 1000 Precision Temperature Measurement

Probe Precision/Device Precision

The device is very precise (please refer to technical data). To be able to use this high precision, the connected temperature probe has to be as precise as possible, too. The following precision classes are available as a standard at reasonable prices (Platinum resistor thermometers according to EN60751):

Class	Error ranges
B	$\pm (0,3 + 0,005 \cdot \text{Temperature})$
A	$\pm (0,15 + 0,002 \cdot \text{Temperature})$
AA (=1/3 DIN B)	$\pm (0,1 + 0,0017 \cdot \text{Temperature})$

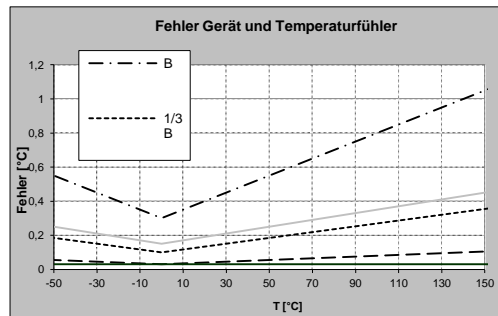

Error over range –50... 150 °C

For applications demanding higher precision than given by this classes we suggest to adjust the device to the used probe or to get a calibration certificate for the device combined with the probe.

Attention: if an adjusted or calibrated probe is replaced, also the adjustment or calibration certificate has to be renewed to maintain the referring overall precision! Be careful when buying third party temperature probes: Besides the standard EN60751 there are some other obsolete or unusual standards on the market. If such a probe has to be connected, the user sensor curve (have a look to the referring chapter) can be used to adjust the instrument!

2-Wire-Measurement

The GMH 285 uses 2 wire measurement, this means, cable and contact resistances may affect measurement precision. For usual cables up to some meters the cable resistance is negligible. Keep contact clean and free from oxidation to avoid contact effects.

Allowable temperature Range Of Probes

Pt100 Sensors are defined over a wide temperature range. Depending on probe materials and sort of sensor (e.g. hybrid sensors, wire wound resistors...) the allowable temperature ranges have to be considered. Exceeding the ranges at least causes a wrong measurement, it may even damage the probe permanently!

Often it also has to be considered, that the temperature range is just valid for the probe tube, (plastic-) handles can't stand the same high temperatures. Therefore the tube length should be selected long enough, that temperature keeps low at the handle.

Self Heating

The measurement current of the instrument is just 0.3mA. Because of this comparably low current practically now self heating effect has to be considered, even at air with low movement the self heating is $\leq 0.01^\circ\text{C}$.

Cooling by Evaporation

When measuring air temperature the probe has to be dry. Otherwise the cooling due to the evaporation causes too low measurement.

Heat loss caused by probe construction:





Especially when measuring temperatures which deviate very much from the ambient temperature, measurement errors often occur if the heat loss caused by the probe is not considered. When measuring fluids therefore the probe should be emerged sufficiently deep and be stirred continuously. When measuring gases the probe should also emerge as deep as possible in the gas to be measured (e.g. when measuring in channel/pipes) and the gas should flow around the probe at sufficient flow.



Measuring Surface Temperature

If temperature of the surface of an object has to be measured, one should pay attention especially when measuring hot (or very cold) surfaces, that the ambient air cools (or heats) the surface. Additionally the object will be cooled (or heated) by the probe or the probe can have a better heat flow to the ambient temperature as to the objects surface. Therefore specially designed surface probes should be used. The measurement precision depends mainly on the construction of the probe and of the physics of the surface itself. If selecting a probe try to choose one with low mass and heat flow from sensor to handle. Thermally conductive paste can increase the precision in some cases.

7 Configuration of the Device

Follow these instructions to configure the functions of the device:

- Switch device off.
- Switch the device on and press  **during the segment test**, until the display shows the first parameter "P.oFF"
- Set parameter with  = up or  = down.
- Jump to the next parameter by pressing .

Parameter	Value	Information
Key 	Keys  	
P.oFF	Auto Power-Off (turn-off delay) <i>factory setting: 20 min.</i>	
	1 ... 120	Auto Power-Off (turn-off delay) in minutes. If no key is pressed for the time adjusted here, the device is automatically switched off (adjustable 1 ... 120 min)
	oFF	Auto power-off is deactivated (continuous operation)
Unit	Display unit <i>factory setting: °C</i>	
	°C	Measuring value displayed in °Celsius
	°F	Measuring value displayed in °Fahrenheit
AL	Alarm setting <i>factory setting: oFF</i>	
	oFF	no alarm monitoring
	on	alarm monitoring via display, interface and sound (Buzzer)
	noSo	alarm monitoring via display, interface, no sound (Buzzer)
ALLo	Alarm setting: Min <i>factory setting: -5.0°C</i>	
	-200.0 ...	Min alarm limit, highest possible value: Max Alarm limit
	ALHi	
ALHi	Alarm setting: Max <i>factory setting: -5.0°C</i>	
	ALLo ...	Max alarm limit, lowest possible value: Min Alarm limit
	400.0	
Adr.	Base Address <i>factory setting: 01</i>	
	01 ... 91	Base address for serial interface communication
LiTE	Backlight -auto-off <i>factory setting: 10 sec.</i>	
	oFF	No backlight
	5 ... 120	Backlight turns automatically off after 5 ... 120 s (battery saving)
	on	Backlight always on as long as device is switched on
Auto HLD	Auto Hold-Function <i>factory setting: oFF</i>	
	on	Auto Hold activated: automatic holding of the measured value, as soon as it is stabilized.
	oFF	Auto Hold deactivated: Value is frozen on keypress (hold)
Init	Restore factory settings	
	no	Parameters are not changed to factory settings.
	YES	ATTENTION: All parameter are changed to factory settings.

Press  again to store changed settings, the device restarts (segment test).

NOTE: If there is no key pressed within the menu mode within 2 minutes, the configuration will be cancelled, the entered settings are lost!





8 Adjustment



The instrument can be adjusted, assuming that: Reliable references are available, such as ice-water regulated precision water baths or similar.

$$\text{Displayed value } ^\circ\text{C} = (\text{measured value } ^\circ\text{C} - \text{OFFS}) * (1 + \text{slope correction} / 100)$$

$$\text{Displayed value } ^\circ\text{F} = (\text{measured value } ^\circ\text{F} - 32 ^\circ\text{F} - \text{OFFS}) * (1 + \text{slope correction} / 100)$$

Follow these instructions to adjust the device:



- Switch the device on.
- Press  and  together until the first parameter "OFFS" is displayed.
- Set parameter with  = up or  = down
- Jump to the next parameter by pressing .

Parameter	Value	Information
Key 	Keys  	
OFFS	OFFSET correction <i>factory setting: oFF = 0.0°C</i>	
	oFF	No offset correction
	-5.0 ... 5.0 °C or -9.0...9.0 °F	Value of offset correction
SCAL	Slope correction <i>factory setting: oFF= 0%</i>	
	oFF	No slope correction
	-5.00 ... 5.00	Value of slope correction in %

Press  again to store changed settings, the device restarts (segment test).

NOTE: If there is no key pressed within the menu mode within 2 minutes, the configuration will be cancelled, the entered settings are lost!

9 Error and System Messages

----	No temperature probe connected Or at GMH 285 BNC: cable/sensor broken Or at GMH 285: cable/sensor shorted
Err. 1	Value exceeding measuring range, value too high or cable/sensor broken
Err. 2	Value exceeding measuring range, value too low or cable/sensor shorted
Err. 7	System error – the device has detected a system error (device defective or not within working temperature)
	The blinking bAt display indicates low battery voltage, device will continue to work for a short time.
	The battery is consumed and has to be changed. Measurements are no longer possible.

10 Accuracy Inspection: Adjustment /Update Service

You can send the device to the manufacture or retailer for adjustment and inspection. Moreover the manufacturer can do the latest software update. This ensures that future improvements are provided to owners of older devices in a cost-saving way. You can display the current software version if you do not release the on/off button after you switched the device on, but hold it for more than 5 seconds. (i.e. "r. 1.0")

11 Disposal Notes



Dispense exhausted batteries at destined gathering places.

This device must not be disposed as 'residual waste'

To dispose this device, please send it directly to us (adequately stamped).

We will dispose it appropriately and environmentally friendly.

12 Technical Data

Measurement	Resistive temperature measuring Pt1000 GMH 285-BNC: BNC socket GMH 285: 3.5mm audio socket
Range	-200,0°C to 400,0°C / -200,0°F to 752,0°F
Resolution	0.1°C / 0.1°F
Accuracy	-100.0 ... 200.0°C: +/-0.1°C +/-1 digits else: +/-0,1 % of measured value +/-1 digits
Frequency	2 measurements per second
Display	4 ½ digits LCD (13 mm) with additional segments
Hold function	Press button to freeze current value. or Auto hold: a stable value will automatically be captured with "HLD"
Min/Max memory	Highest and lowest values after switching on are memorized
Alarm	Freely configurable min/max alarm via buzzer, display and interface
Adjustment	Menu: offset/scale, factory settings are recoverable
Working temperature	-25 to 50°C
Storage temperature	-25 to 70°C
Power supply	9V battery, type: IEC 6F22 (included in scope of supply), external d.c. connector
Power consumption	< 0.20 mA (battery life time: more than 1500 hours for alkaline battery)
battery state display	Backlight: <5mA, will be automatically switched of at "BAT"-warning "bAt" displayed in main display, if battery used up, warning symbol: "BAT" for weak battery
Auto off-function	Device will be automatically switched off if not operated for longer time (adjustable from 1..120 min)
Housing	impact-resistant ABS plastic housing
Protection class	Front side IP65
Dimensions	without BNC connector 142 x 71 x 26 mm (L x B x H) BNC connector at the devices front end: approx. 13 mm long
Weight	Approx. 170 g incl. battery
EMC	The device corresponds to the essential protection ratings established in the Regulations of the Council for the Approximation of Legislation for the member countries regarding electromagnetic compatibility (2004/108/EG), additional error: < 1% FS